



ECONOMIC BENEFITS OF INCREASING ELECTRIC GRID RESILIENCE TO WEATHER OUTAGES

Executive Office of the President

August 2013



This report was prepared by the President's Council of Economic Advisers and the U.S. Department of Energy's Office of Electricity Delivery and Energy Reliability, with assistance from the White House Office of Science and Technology

Executive Summary

Severe weather is the leading cause of power outages in the United States. Between 2003 and 2012, an estimated 679 widespread power outages occurred due to severe weather. Power outages close schools, shut down businesses and impede emergency services, costing the economy billions of dollars and disrupting the lives of millions of Americans. The resilience of the U.S. electric grid is a key part of the nation's defense against severe weather and remains an important focus of President Obama's administration.

In June 2011, President Obama released *A Policy Framework for the 21st Century Grid* which set out a four-pillared strategy for modernizing the electric grid. The initiative directed billions of dollars toward investments in 21st century smart grid technologies focused at increasing the grid's efficiency, reliability, and resilience, and making it less vulnerable to weather-related outages and reducing the time it takes to restore power after an outage occurs.

Grid resilience is increasingly important as climate change increases the frequency and intensity of severe weather. Greenhouse gas emissions are elevating air and water temperatures around the world. Scientific research predicts more severe hurricanes, winter storms, heat waves, floods and other extreme weather events being among the changes in climate induced by anthropogenic emissions of greenhouse gasses.

This report estimates the annual cost of power outages caused by severe weather between 2003 and 2012 and describes various strategies for modernizing the grid and increasing grid resilience. Over this period, weather-related outages are estimated to have cost the U.S. economy an inflation-adjusted annual average of \$18 billion to \$33 billion. Annual costs fluctuate significantly and are greatest in the years of major storms such as Hurricane Ike in 2008, a year in which cost estimates range from \$40 billion to \$75 billion, and Superstorm Sandy in 2012, a year in which cost estimates range from \$27 billion to \$52 billion. A recent Congressional Research Service study estimates the inflation-adjusted cost of weather-related outages at \$25 to \$70 billion annually (Campbell 2012). The variation in estimates reflects different assumptions and data used in the estimation process. The costs of outages take various forms including lost output and wages, spoiled inventory, delayed production, inconvenience and damage to the electric grid. Continued investment in grid modernization and resilience will mitigate these costs over time – saving the economy billions of dollars and reducing the hardship experienced by millions of Americans when extreme weather strikes.

I. Introduction

The U.S. electric grid (“the grid”) constitutes a vital component of the nation’s critical infrastructure and serves as an essential foundation for the American way of life. The grid generates, transmits, and distributes electric power to millions of Americans in homes, schools, offices, and factories across the United States. Investment in a 21st century modernized electric grid has been an important focus of President Obama’s administration. A modern electric grid will be more reliable, efficient, secure, and resilient to the external and internal cause of power outages – improving service for the millions of Americans who rely on the grid for reliable power.

Severe weather is the number one cause of power outages in the United States and costs the economy billions of dollars a year in lost output and wages, spoiled inventory, delayed production, inconvenience and damage to grid infrastructure. Moreover, the aging nature of the grid – much of which was constructed over a period of more than one hundred years – has made Americans more susceptible to outages caused by severe weather. Between 2003 and 2012, roughly 679 power outages, each affecting at least 50,000 customers, occurred due to weather events (U.S. Department of Energy).

The number of outages caused by severe weather is expected to rise as climate change increases the frequency and intensity of hurricanes, blizzards, floods and other extreme weather events. In 2012, the United States suffered eleven billion-dollar weather disasters – the second-most for any year on record, behind only 2011. The U.S. energy sector in general, and the grid in particular, is vulnerable to the increasingly severe weather expected as the climate changes (DOE 2013).

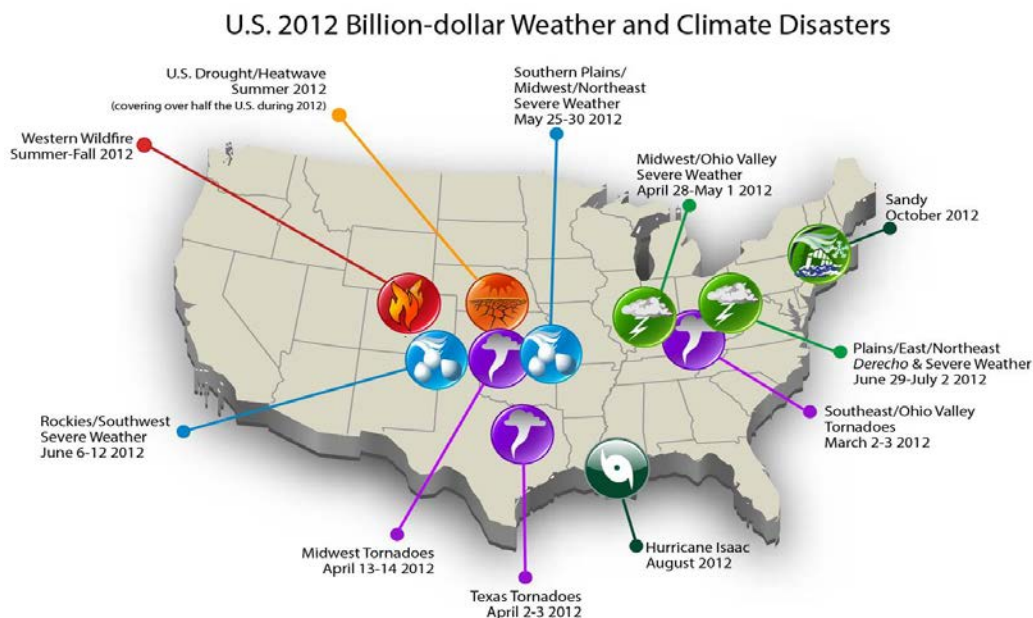

Source: National Oceanic and Atmospheric Administration

The American Recovery and Reinvestment Act of 2009 (“Recovery Act”) allocated \$4.5 billion to the U.S. Department of Energy (DOE) for investments in modern grid technology which have begun to increase the resilience and reliability of the grid in the face of severe weather (Executive Office of the President 2013). A more resilient grid is one that is better able to sustain and recover from adverse events like severe weather – a more reliable grid is one with fewer and shorter power interruptions. Methods for improving the resilience and reliability of the grid include both high and low-tech solutions.

This report begins by describing the current state of the U.S. electric grid, the impact of widespread power outages caused by severe weather, and the increasing intensity and frequency of severe weather due to climate change. The report then documents numerous strategies for increasing the grid resilience and reliability. Lastly, an economic model is presented and used to estimate the annual cost of power outages caused by severe weather in the United States. The benefits of increased grid resilience include the avoided cost of these outages.

II. Status and Outlook of the Electric Grid

The grid delivers electricity to more than 144 million end-use customers in the United States (U.S. Energy Information Administration 2013). The grid consists of high-voltage transmission lines, local distribution systems, and power management and control systems.¹ Electricity is produced at generation facilities and transported to population centers by high-voltage transmission lines. After arriving at population centers, electricity enters local distribution systems where it travels through a series of low-voltage lines in a process called “stepping down” before reaching homes, offices and other locations for consumption. The grid connects Americans with 5,800 major power plants and includes over 450,000 miles of high voltage transmission lines (American Society of Civil Engineers 2012).

¹ Although the grid also includes generation facilities, this report focuses on the status and outlook of the grid’s transmission, distribution and management/control systems.

Basic Structure of the U.S. Electric Grid

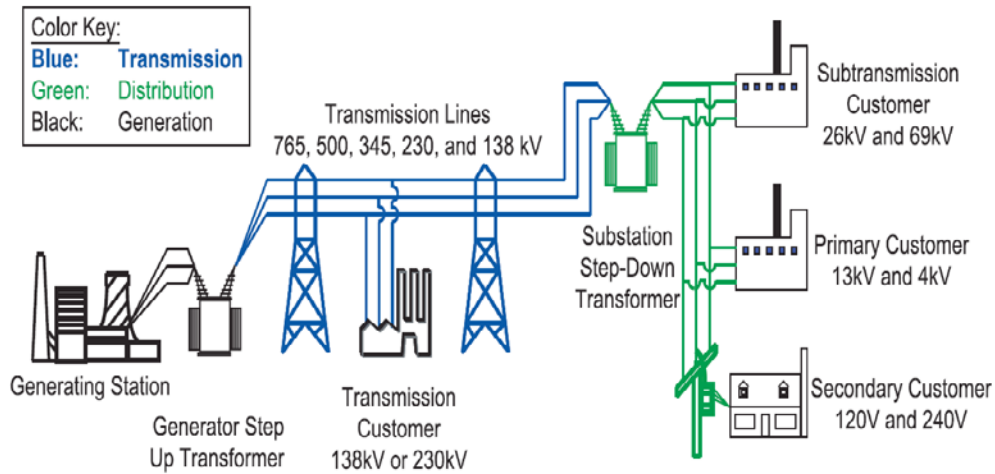

Source: U.S. Canada Power System Outage Task Force

The transmission grid consists of eight regions and is overseen by the North American Electric Reliability Corporation (NERC), a non-profit entity responsible for the reliability of the bulk power system in North America (including the United States and Canada), subject to the oversight of the Federal Energy Regulatory Commission (FERC). The U.S. electric system is primarily comprised of three interconnections (Eastern, Western and Texas interconnection). The three interconnections are linked by direct current (DC) transmission lines which limit and control the amount of electricity transferred between them. Within each interconnection, electricity travels through a network of alternating current (AC) transmission lines.

North American Reliability Corporation, Grid Regions



Source: North American Reliability Corporation

Most of the grid is privately owned by for-profit utility companies. Since public utilities are natural monopolies, government agencies regulate electric rates and operating practices. State

agencies regulate the rates charged by local utilities while both federal and state governments oversee the operation of generating facilities and transmission systems (ASCE 2012). Electric utilities are defined as any entity generating, transmitting or distributing electricity. Utilities can be either publicly-owned, investor-owned or cooperatives. As of 2010, roughly 62 percent of utilities were publicly-owned; however, investor-owned utilities serve the majority of customers (68 percent) (American Public Power Association 2012).

Construction of the grid began in the late 1880s and continues today – albeit at a significantly slower pace. In the mid-2000s, transmission lines across all eight NERC regions were built at a rate of roughly 1,000 circuit miles per year. This rate more than doubled to 2,300 circuit miles in the five years leading up to a NERC reliability assessment published in 2012. Despite the increase, projected construction of transmission lines remains well below the rates experienced between 1960 and 1990 (Pfeifenberger 2012). Seventy percent of the grid’s transmission lines and power transformers are now over 25 years old and the average age of power plants is over 30 years (Campbell 2012).

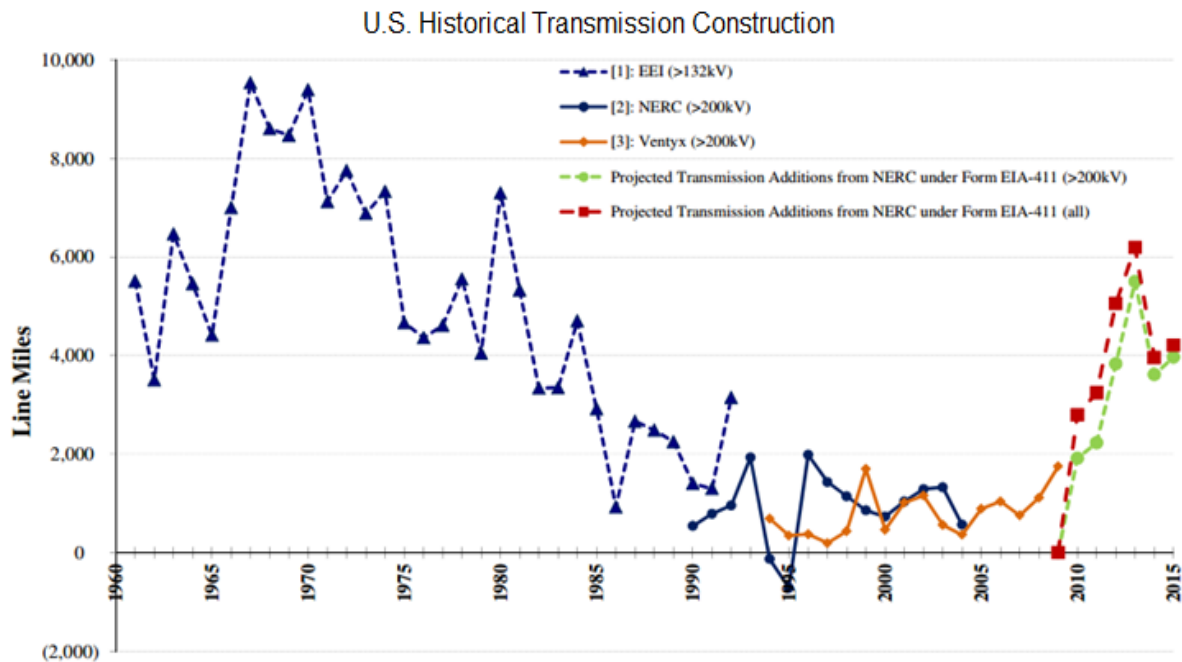

Source: The Brattle Group, 2012

The age of the grid’s components has contributed to an increased incidence of weather-related power outages. For example, the response time of grid operators to mechanical failures is constrained by a lack of automated sensors. Older transmission lines dissipate more energy than new ones, constraining supply during periods of high energy demand (ABB Inc. 2007). And, grid deterioration increases the system’s vulnerability to severe weather given that the majority of the grid exists above ground.

In response to the growing need for grid modernization, the federal government has allocated billions of dollars to replace, expand and refine grid infrastructure. The American Recovery and Reinvestment Act of 2009 (“Recovery Act”) allocated \$4.5 billion for investments in modern grid technology (EOP 2013). Smart grid technology utilizes remote control and automation to better monitor and operate the grid. Between June 2011 and February 2013, Recovery Act funds have been used to deploy 343 advanced grid sensors, upgrade 3,000 distribution circuits with digital technology, install 6.2 million smart meters and invest in 16 energy storage projects (EOP 2013). These investments have contributed to significant increases in grid resilience, efficiency and reliability.

III. Impact of Severe Weather on the U.S. Electric Grid

Severe weather is the single leading cause of power outages in the United States. Outages caused by severe weather such as thunderstorms, hurricanes and blizzards account for 58 percent of outages observed since 2002 and 87 percent of outages affecting 50,000 or more customers (U.S. DOE, Form OE-417). In all, 679 widespread outages occurred between 2003 and 2012 due to severe weather.² Furthermore, the incidence of both major power outages and severe weather is increasing. Data from the U.S. Energy Information Administration show that weather-related outages have increased significantly since 1992.

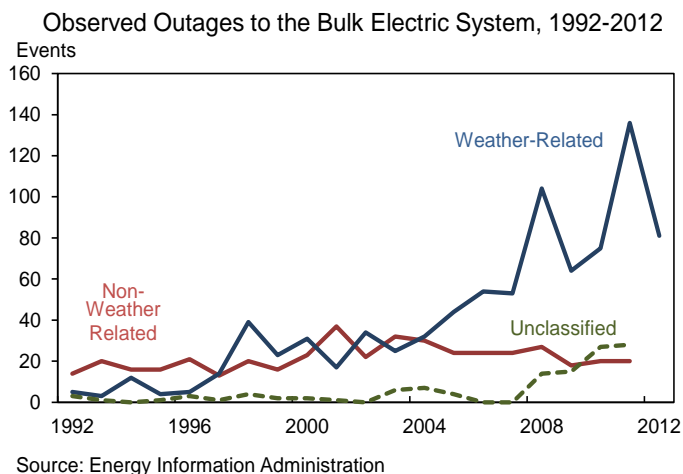

² Other causes of power outages include: operational failures, equipment malfunctions, circuit overloads, vehicle accidents, fuel supply deficiencies and load shedding – which occurs when the grid is intentionally shut down to contain the spread of an ongoing power outage (U.S. DOE, Form OE-417).

Since 1980, the United States has sustained 144 weather disasters whose damage cost reached or exceeded \$1 billion. The total cost of these 144 events exceeds \$1 trillion (U.S. Department of Commerce 2013). Moreover, seven of the ten costliest storms in U.S. history occurred between 2004 and 2012 (U.S. DOC 2012). These “billion dollar storms” have rendered a devastating toll on the U.S. economy and the lives of millions of Americans.

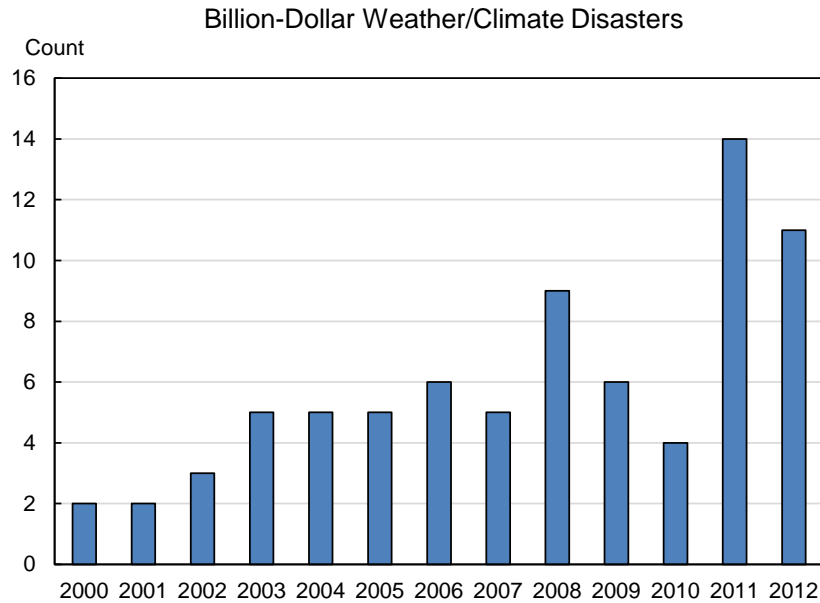

Source: National Oceanic and Atmospheric Administration (NOAA)

According to the National Climate Assessment, the incidence and severity of extreme weather will continue to increase due to climate change. The 2009 assessment of the U.S. Global Change Research Program (USGCRP) on behalf of the National Science and Technology Council found that anthropogenic emissions of greenhouse gases are causing various forms of climate change including higher national and global temperatures, warmer oceans, increased sea levels, and more extreme weather events (USGCRP 2009). The increased incidence of severe weather represents one of the most significant threats posed by climate change (USGCRP 2013).

Climate change is expected to alter patterns of precipitation. Northern areas of the United States are projected to become wetter, especially in the winter and spring, while southern areas are projected to become drier. In addition, heavy precipitation events will become more frequent. Depending on location, severe downpours currently occurring once every 20 years are projected to occur every 4 to 15 years by 2100 (USGCRP 2009).

In addition to higher temperatures and changing patterns of precipitation, scientists expect warmer ocean temperatures to increase hurricane intensity. Hurricanes draw energy from the temperature difference between ocean surfaces and the mid-level atmosphere. Over the past three decades, the North Atlantic has already experienced the trend of increasing hurricane intensity (Kossin et al. 2007). Moreover, several studies project a substantial increase in

hurricane-related costs due to climate change (Mendelsohn et al. 2012; Nordhaus 2010; Narita et al. 2009). Similarly, winter storms will also become stronger, more frequent, and costly (USGCRP 2009). Investment in modern infrastructure will be required to maintain grid reliability as these weather changes occur.

Case Study: Superstorm Sandy

Superstorm Sandy made landfall near Atlantic City, New Jersey as a post-tropical cyclone on October 29, 2012 and then continued northwest over New Jersey, Delaware and Pennsylvania. The heaviest damage was due to record floods in New York and New Jersey. A storm surge of 12.65 feet hit New York City causing flooding of 4 to 11 feet in Lower Manhattan. New Jersey experienced a storm surge of 8.57 feet which caused flooding of 2 to 9 feet in ten counties across the state. In all, the storm damaged 650,000 homes and knocked out power for 8.5 million customers.

Sandy directly caused the deaths of 72 people in the United States and an estimated \$65 billion in damages – the second-costliest cyclone to hit the U.S. since 1900. Sandy indirectly caused the death of another 87 people, 50 of which were attributed to power outages. Numerous senior citizens without heat died from hypothermia while other victims died of carbon monoxide poisoning due to improperly vented generators (U.S. DOC 2013; Blake 2013).

Smart grid investments made by the U.S. Department of Energy's Smart Grid Investment Grant (SGIG) in some of the states hit by Sandy lessened the impact for thousands of electric customers. For example, In Philadelphia, roughly 186,000 smart meters were up and running by the time Sandy hit. The Philadelphia Electric Company (PECO) estimated that about 50,000 customers experienced shorter outages due to its new smart grid systems, which also included upgrades to its Outage Management System (OMS). PECO observed more than 4,000 instances where smart meters were able to remotely determine when power was restored, saving PECO and its customers time and money.

In the Washington D.C. metropolitan area, the Potomac Electric Power Company (PEPCO) said it was able to restore power to 130,000 homes in just two days after Sandy thanks to advanced meter infrastructure (AMI) deployed under its SGIG projects. With smart meters and AMI connecting roughly 425,000 homes, PEPCO received "no power" signals that allowed them to quickly pinpoint outage locations. The signals arrived at PEPCO's central monitoring center, allowing the company to respond to customers quickly and effectively. After power was restored, PEPCO continually "pinged" the meters to verify service restoration, thus avoiding the need to send repair crews.



Hurricane Sandy Power Outages

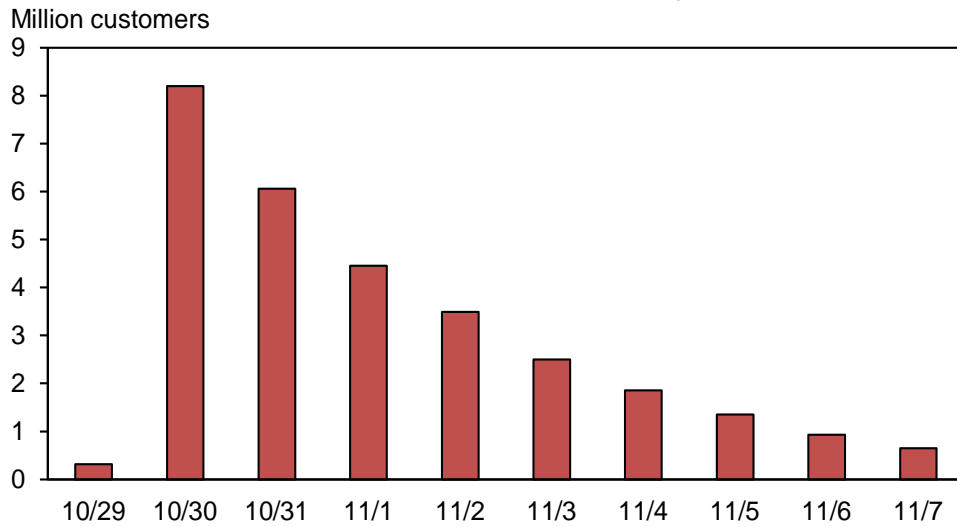

Source: Department of Energy

Case Study: Hurricane Irene

Hurricane Irene made landfall near Cape Lookout, North Carolina on August 27, 2011 as a category one hurricane and then continued north-eastward making a second landfall near Atlantic City, New Jersey. Irene's most significant impact was on the mid-Atlantic states through New England with the heaviest damage occurring in New Jersey, Massachusetts and Vermont due to inland flooding (Avila and Cangialosi 2011). In all, 2.3 million people were mandatorily evacuated in advance of Irene's devastation (U.S. DOC, 2011).

More than 6.5 million people in the United States lost power during Hurricane Irene, which includes over 30 percent of the people living in Rhode Island, Connecticut and Maryland (U.S. DOE 2011). Irene caused the death of 41 people in the United States and resulted in \$15.8 billion in total damages (Avila and Cangialosi 2011) - the seventh costliest hurricane in U.S. history (U.S. DOC 2012a).

Smart grid investments made before Irene's landing lessened the storm's impact for thousands of electric customers. Investments in advanced metering infrastructure (AMI) improved outage notification and response time, greatly reducing the duration of outages. In Pennsylvania, the Pennsylvania Power & Light's (PPL) smart grid investments in distribution automation technologies made a difference for 388,000 customers who lost power.



IV. Strategies for Achieving Grid Resilience

Grid resilience, a core requirement for climate adaptation, includes hardening, advanced capabilities, and recovery/reconstitution. Although most attention is placed on best practices for hardening, resilience strategies must also consider options to improve grid flexibility and control. Resilience includes reconstitution and general readiness such as pole maintenance, vegetation management, use of mobile transformers and substations, and participation in mutual assistance groups. This section summarizes several key ways to improve grid resilience. Additional details are provided in the U.S. Department of Energy report (DOE 2010a).

Grid resilience strategies require a partnership across all levels of government and the private sector to promote a regional and cross-jurisdictional approach. Because the electric grid cannot be 100 percent secure, the strategy must identify the greatest risks to the system and determine the cost and impact to mitigation/hardening strategies to advance the capability of the grid. Furthermore, the 2003 Northeast Blackout and the 2011 Southwest Blackout raised several reliability issues and technology limitations that add complexity to grid resilience. Although this report focuses on the economic benefit of avoiding outages related to severe weather, grid resilience encompasses an all-hazard approach.

Priority 1: Manage Risk

Risk management is a process that examines and evaluates policies, plans, and actions for reducing the impact of a hazard or hazards on people, property and the environment. Managing expectations is an important aspect of risk management because risk to the grid cannot be completely eliminated even with the most appropriate and successful strategies. (The National Academies Press 2012).

An important part of assessing risk is the ability to conduct exercises to identify and mitigate the potential impacts of identified hazards. In 2011, the Department of Energy conducted four major regional exercises across the country. One of the scenarios for the Northeast Exercise simulated a hurricane. The simulated hurricane closely resembled Hurricane Irene and produced an estimate of 6.4 million customers without power.

Individual utilities also engage in storm preparation, response planning, and readiness exercises. These activities are important, as is communication and coordination among utilities and participation in mutual aid programs.

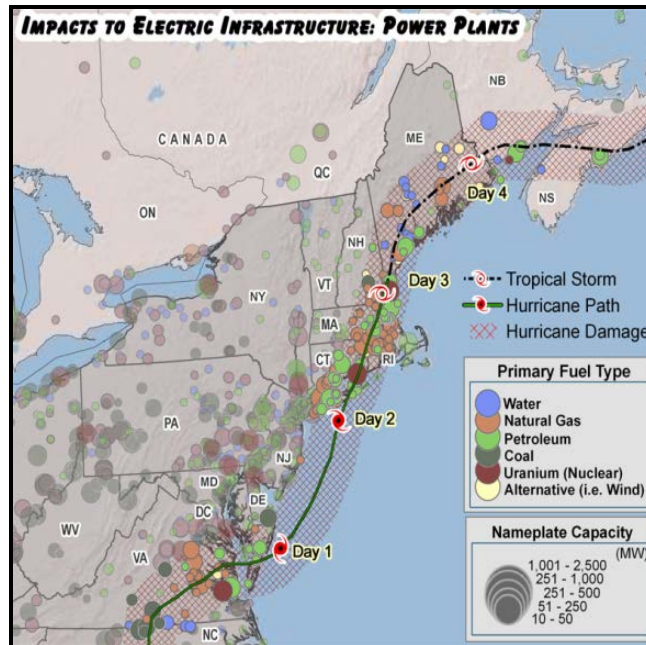

Priority 2: Consider Cost-Effective Strengthening

Electricity is a critical element of the highly interdependent energy supply and distribution system. A refinery or pipeline pumping station, even if undamaged by a hurricane, will not be able to operate without access to electricity. Most utilities have active plans in place to harden their infrastructure against wind and flood damage. In fact, since 2005, multiple state public utility commissions have issued rulemakings and/or regulatory activities related to electricity infrastructure hardening.

Hurricane-force winds are the primary cause of damage to electric utility transmission and distribution (T&D) infrastructure. Upgrading poles and structures with stronger materials constitutes a primary hardening strategy. For distribution systems, this usually involves upgrading wooden poles to concrete, steel, or a composite material, and installing support wires and other structural supports. For transmission systems, this usually involves upgrading aluminum structures to galvanized steel lattice or concrete. In addition, adequate vegetation management programs can help prevent damage to T&D infrastructure. Although transmission system outages do occur, roughly 90 percent of all outages occur along distribution systems (Edison Electric Institute).

Placing utility lines underground eliminates the distribution system's susceptibility to wind damage, lightning, and vegetation contact. However, underground utility lines present significant challenges, including additional repair time and much higher installation and repair costs. Burying overhead wires costs between \$500,000 and \$2 million per mile, plus expenses for coolants and pumping stations. Perhaps the most important issue for coastal regions is that

underground wires are more vulnerable to damage from storm surge flooding than overhead wires.

Common hardening activities to protect against flood damage include elevating substations and relocating facilities to areas less prone to flooding. Unlike petroleum facilities, distributed utility T&D assets are not usually protected by berms or levees. Replacing a T&D facility is far less expensive than building and maintaining flood protection. Other common hardening activities include strengthening existing buildings that contain vulnerable equipment, and moving equipment to upper floors where it will not be damaged in the event of a flood.

Case Study: Florida Power & Light Company

Florida Power & Light Company (FPL) expects to invest approximately half a billion dollars between 2013 and 2015 to improve electric system resilience for its customers. The plan builds on the company's storm hardening initiative by incorporating additional lessons learned from Superstorm Sandy, such as those related to flooding, as well as from Florida storm activity in 2012. These recent experiences show that strengthened electric infrastructure reduces storm-related outages and reduces restoration times when outages occur. Specifically, FPL's 2013-2015 investment plans include: 1) hardening for critical facilities and other essential community needs, 2) accelerated deployment of wind-resilient transmission structures and equipment, and 3) strengthened equipment in areas most vulnerable to storm surges. (Florida Power & Light Company 2013, DOE 2012a)

Priority 3: Increase System Flexibility and Robustness

Additional transmission lines increase power flow capacity and provide greater control over energy flows. This can increase system flexibility by providing greater ability to bypass damaged lines and reduce the risk of cascading failures. Power electronic-based controllers can provide the flexibility and speed in controlling the flow of power over transmission and distribution lines.

Energy storage can also help level loads and improve system stability. Electricity storage devices can reduce the amount of generating capacity required to supply customers at times of high energy demand – known as peak load periods. Another application of energy storage is the ability to balance microgrids to achieve a good match between generation and load. Storage devices can provide frequency regulation to maintain the balance between the network's load and power generated. Power electronics and energy storage technologies also support the utilization of renewable energy, whose power output cannot be controlled by grid operators.

A key feature of a microgrid is its ability during a utility grid disturbance to separate and isolate itself from the utility seamlessly with little or no disruption to the loads within the microgrid. Then, when the utility grid returns to normal, the microgrid automatically resynchronizes and reconnects itself to the grid in an equally seamless fashion. Technologies include advanced

communication and controls, building controls, and distributed generation, including combined heat and power which demonstrated its potential by keeping on light and heat at several institutions following Superstorm Sandy.³

Priority 4: Increase Visualization and Situational Awareness

Until recently, most utilities became aware that customers had lost power when the customers called to report the outage. Thus utilities have had incomplete information about outage locations, resulting in delayed and inefficient responses. Smart meters have outage notification capabilities which make it possible for utilities to know when customers lose power and to pinpoint outage locations more precisely. Smart meters also indicate when power has been restored. When the outage notification capability enabled by smart meters is coupled with automated feeder switching, the result is a significant improvement in field restoration efforts since field crews can be deployed more efficiently, saving time and money. The Recovery Act investment has added greater visibility and intelligence across the electric system through advanced outage management systems, distribution management tools as well as transmission visibility.

Another example, synchrophasor technology, derived from phasor measurement units (PMUs), is used within the transmission system to provide high-fidelity, time-synchronized visibility of the grid. PMUs enable operators to identify reliability concerns, mitigate disturbances, enhance the efficiency/capacity of transmission system, and help manage islanding during emergency situations.

³ Stony Brook University, "In the Aftermath of Superstorm Sandy: A Message from President Stanley," <http://www.stonybrook.edu/sb/sandy/index.shtml>; ICF International, "Combined Heat and Power: Enabling Resilient Energy Infrastructure for Critical Facilities," 03/2013, http://www1.eere.energy.gov/manufacturing/distributedenergy/pdfs/chp_critical_facilities.pdf.

Case Study: Entergy Corporation

During Hurricane Gustav in 2008, Entergy, an energy company responsible for delivering power to customers in Arkansas, Louisiana, Mississippi and Texas, had 14 transmissions trip-out-of-service in the Baton Rouge to New Orleans area which created a Baton Rouge-New Orleans electrical island for 33 hours, meaning interconnection to the grid was lost. During this period, Entergy was able to control the island's frequency, balance three large generating units, and maintain electric service to customers because of the 21 PMUs the company had installed across a four-state area. PMUs identified and warned of islanding conditions during emergencies and provided Entergy with insight into how to manage islands and where else in the territory additional PMUs were needed. Entergy's success with PMUs during Gustav demonstrated that these devices had moved from being optional equipment to vital components of a modern electric grid (Galvan et al. 2008).

Priority 5: Deploy Advanced Control Capabilities

Many of the recipients of Recovery Act funds are deploying automated feeder switches that open or close in response to a fault condition identified locally or to a control signal sent from another location. When a fault occurs, automated feeder switching immediately reroutes power among distribution circuits isolating only the portion of a circuit where the fault has occurred. The result is a significant reduction in the number of customers affected by an outage and the avoidance of costs typically borne by customers when outages occur.

One recent example involves EPB of Chattanooga who estimated that power outages resulted in an annual cost of \$100 million to the community and installed automated fault isolation and service restoration technology. During a July 2012 wind storm, automated switching in the distribution system instantly reduced the number of sustained outages by 50 percent to 40,000 customers. When coupled with information on customer outage provided by meters, the utility was able to avoid 500 truck rolls and reduce total restoration time by 1.5 days, representing almost \$1.5 million in operational savings and significant avoidance of costs to customers.

The reports for both the 2011 Arizona-Southern California and 2003 Northeast blackouts illustrate that real-time monitoring tools were inadequate to alert operators to rapidly changing system conditions and contingencies (FERC/NERC 2012). Providing operators with new tools that enhance visibility and control of transmission and generation facilities could help them manage the range of uncertainty caused by variable clean electricity generation and smart load, thus enhancing the understanding of grid operations.

Priority 6: Availability of Critical Components and Software Systems

Installing equipment health sensors can reveal possibilities for premature failures. Typically, these devices are applied on substations and other equipment whose failure would result in significant consequences for utilities and customers. When coupled with data analysis tools,

equipment health sensors can provide grid operators and maintenance crews with alerts and actionable information. Actions may include taking equipment offline, transferring load to alleviate stress on critical components, or repairing equipment. Understanding equipment condition allows utilities to undertake predictive and targeted maintenance. As a result, utilities can employ asset management strategies that lead to greater availability of critical components.

Large power transformers are custom-designed equipment that entail significant capital expenditures and long lead times due to an intricate procurement and manufacturing process. These transformers can cost millions of dollars and weigh between approximately 100 and 400 tons. The domestic production capacity for large power transformers in the United States is improving. In addition to EFACEC’s first U.S. transformer plant that began operation in Rincon, Georgia in April 2010, at least three new or expanded facilities will produce extra high voltage large power transformers (U.S. DOE 2012b).

V. The Economic Benefit of Modernization and Increased Grid Resilience

The significant impact of severe weather on the U.S. electric grid showcases the importance of investment in grid modernization. A modern electric grid will be more resilient to severe weather, meaning outages will affect fewer customers for shorter periods of time. This report estimates the annual cost of outages caused by severe weather.

The Cost of Power Outages

Several studies have estimated the total cost of power outages in the United States, including those caused by weather and those caused by non-weather related events. These studies are based on estimates of utility customers’ value of service reliability, which is in turn estimated either by surveys of willingness to pay for avoided outages or by survey estimates of the direct costs of outages (Sullivan et al. 2009).

Previous Estimates of Annual Cost of Power Outages		
Source	Estimate (2012 dollars)	Year published
All outages		
Swaminathan and Sen	\$59 billion	1998
PRIMEN	\$132 to \$209 billion	2001
LaCommare & Eto	\$28 to \$169 billion	2005
Weather-related outages		
Campbell (CRS)	\$25 to \$70 billion	2012

An early estimate of the total cost of power outages was developed by Swaminathan and Sen in 1998. The estimate uses data from a 1992 Duke Power survey on the cost of outages to the U.S. industrial sector. The study focuses solely on industrial customers and excludes the commercial and residential sectors. The study extrapolates survey data from industrial firms in the southeastern region of the United States to estimate the cost of outages to industrial firms across the country. Evidence suggests, however, that the cost of outages to industrial customers varies significantly by geographic region (Lawton et al. 2003).

In 2001, Primen Inc., a consulting firm now a part of the Electric Power Research Institute, estimated the total cost of power outages using survey data from 985 industrial and digital economy (DE) firms. Unlike Swaminathan and Sen, Primen's survey was representative of firms in all geographic regions of the United States. Industrial and DE firms were chosen due to their sensitivity to power outages and important contribution to U.S. GDP. Each firm was asked to estimate the cost of hypothetical outages varying in duration, time of day and whether or not the outage was expected.⁴ The results of the surveys were extrapolated across all business sectors to determine the total annual cost of outages. Like Swaminathan and Sen, Primen's inflation-adjusted cost estimate of \$132 billion to \$209 billion does not account for the cost of outages to residential customers.

In 2005, LaCommare and Eto estimated the total cost of power outages using national statistics reported by utility firms on outage frequency and duration. The cost of each outage was determined using a cost function calculated in Lawton et al. 2003. Lawton based the function on survey data gathered from various customer groups on the cost of outages. Using Lawton's cost function, LaCommare and Eto found that two-thirds of the annual cost of outages was caused by those lasting less than five minutes ("momentary outages"). According to LaCommare and Eto, this is due to the high frequency of momentary outages relative to sustained outages.

It appears that the only prior estimate of the cost of outages caused specifically by weather was published by the Congressional Research Service in 2012 (Campbell 2012). Campbell estimated the inflation-adjusted annual cost of weather-related outages in the United States to be between \$25 billion and \$70 billion. Campbell's calculations draw on prior estimates of the total cost of outages, outage duration and the fraction of outages due to weather.^{5,6}

⁴ This valuation method is known as direct cost estimation (or "direct costing") and is widely used by utilities to assess the value of power reliability (PRIMEN 2001).

⁵ Campbell's estimate of the cost of outages caused by weather-events was derived in two steps. First, Campbell calculated the cost of outages lasting longer than five minutes ("sustained outages"). The cost of sustained outages was calculated by multiplying Primen's 2001 estimate of the total cost of outages (\$132 to \$209 billion) by the

New Estimate of the Cost of Weather-Related Outages

This report provides new estimates of the annual cost of power outages caused by weather. The estimates are based on value-of-service (VOS) data compiled by Sullivan et al. (2009), originally collected by major electric companies using customer surveys. A range of costs is calculated for each year between 2003 and 2012. These annual estimates are then used to calculate a range of the inflation-adjusted average annual cost.

The estimate in this report uses data from the U.S. Department of Energy on power outages occurring between 2003 and 2012 and composite VOS estimates by customer type (residential, commercial and industrial).

Value-of service data. Customer value-of-service was calculated as a function of outage duration using a model from Sullivan et al. (2009). Sullivan et al. provides original VOS estimates for various customer groups using data from 28 consumer surveys conducted by 10 major electric companies between 1989 and 2005. These surveys assessed the cost of power outages to residential customers and commercial/industrial customers of varying size. Commercial and industrial customers were surveyed using the direct cost method. Each firm was asked to estimate the cost of hypothetical power interruptions varying in duration, time of day and whether or not the outage was expected. Residential customers were asked to report their willingness to pay to avoid similar outages. The willingness to pay (WTP) method is a form of contingent valuation – a method used in economics to value goods and services not bought or sold in a marketplace. The willingness to pay method was used to estimate the cost to residential customers because – unlike firms – a substantial fraction of foregone consumer welfare (i.e. being without heat) does not translate into direct costs borne by residents.⁷

percentage of outages lasting longer than five minutes (43 percent). Campbell excluded momentary outages since they are rarely caused by weather events. Second, Campbell calculated the cost of outages caused by weather by multiplying the cost of sustained outages by the percentage of outages due to weather-events. Campbell used two different estimates for the percentage of outages due to weather – one from the University of Vermont (44 percent) and one from the Lawrence Berkeley Laboratory (78 percent) (Hines 2008; Mills 2012). The two estimates were used to calculate a range of the inflation-adjusted cost of outages caused by weather: \$25 billion to \$70 billion.

⁷ The contingent valuation method (CV) – which includes willingness to pay measures – has been the subject of academic debate. In 1993, the National Oceanic and Atmospheric Administration (NOAA) convened a panel chaired by two Nobel Laureate economists to assess the validity of CV measures. The panel concluded that, if correctly implemented, the CV method provides reliable value estimates. The panel then established a set of universal guidelines for effective CV surveys. Subsequent literature has further advanced the understanding and

The utility surveys compiled by Sullivan et al. (2009) are not necessarily random samples of all utility customers. Two different weighting schemes were therefore used to adjust the estimates to reflect the current distribution of residential, commercial, and industrial customers as reported by the U.S. Bureau of Economic Analysis. These two different weighting schemes yield two different estimates of the average VOS for an outage of a given duration.

Outage distribution data. The U.S. Department of Energy tracks the cause, duration and number of customers affected for each power outage reported in a given year.⁸ Outages are reported to DOE by electric utilities under a mandatory reporting requirement. This mandatory reporting dataset is henceforth referred to as the DOE MRDS. For major storms like Superstorm Sandy and Hurricane Irene, DOE also tracks the power restoration process. The number of customers without power in major storms is published in Emergency Situation Reports twice a day during the storm and with decreasing frequency in the days that follow.⁹

The next figure shows the distributions of customer power outages for fifteen major storms occurring between 2004 and 2012¹⁰. In the plot, the peak number of customers affected is normalized to one for comparability. The distribution shows the fraction of customers without power, as a percentage of the peak number of customers without power, at any given time during the outage event.

All of the fourteen storm-outage-profiles resemble one another, even though they range in duration from 3 to 20 days. The number of customers affected rises sharply in the first few hours of the event and peaks 15 to 25 percent into the total duration. Power is restored to a majority of customers relatively quickly, however a substantial number of customers remain without power long after the event begins. The fourteen storm profiles were used to construct a representative profile shown in black on the chart below. This representative profile was then applied to all power outages caused by weather reported in the DOE MRDS.¹¹

validity of the method – see Carson et al. 1996; Carson 1997; Foreit and Foreit 2002; and Johnston and Joglekar 2005.

⁸ The data are compiled in Electric Emergency Incident and Disturbance Reports available at <http://www.oe.netl.doe.gov/oe417.aspx>.

⁹ See http://www.oe.netl.doe.gov/emergency_sit_rpt.aspx.

¹⁰ The chosen storms are all non-overlapping storm events reported in the Emergency Situation Reports with at least seven published outage reports, thereby providing enough distinct outage and time observations to compute a useful empirical customer outage profile.

¹¹ In instances in which a storm has Emergency Situation Reports and can be identified in the DOE MRDS, data from the reports are used in place of the mandatory reporting data.

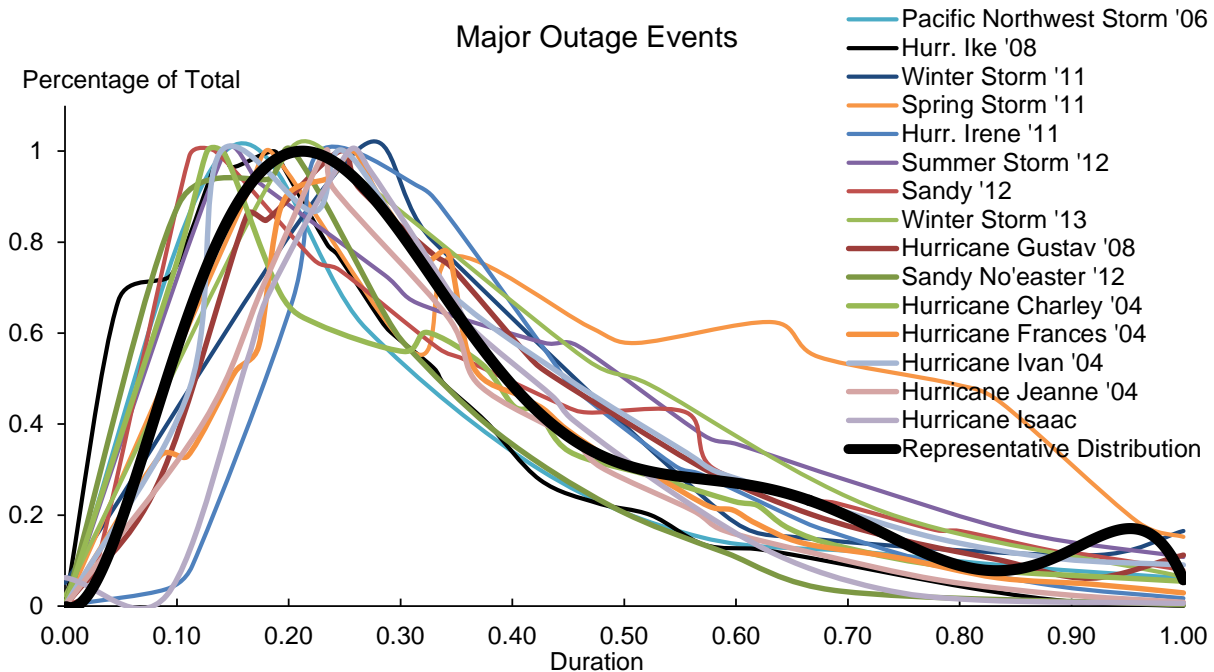

Source: Department of Energy, Office of Electricity Delivery and Energy Reliability

Estimate of the cost of weather-related outages. Outage cost was calculated using the two sets of VOS estimates derived using Sullivan et al. (2009). The cost of an outage was calculated twice since each set of VOS estimates results in a different outage cost estimate. Using each set of VOS estimates, a weighted cost was calculated for outages of different durations. The weighted cost function was derived by assigning weights to Sullivan et al.'s customer groups based on each group's share of the total pool of electricity customers.

After calculating a weighted cost for each outage duration, an average cost function was determined for U.S. electric customers. The total cost of each outage in the DOE MRDS was estimated using the average per-customer cost function aggregated by the number of customers affected and the outage duration distribution. Finally, outage costs were aggregated by year and adjusted for inflation. Because the calculations were performed using each set of VOS estimates, two estimates of the annual cost of outages are provided for each year. Across all ten years, the average annual cost of outages caused by weather ranges from \$18 to \$33 billion.

The estimated costs by year are provided in the following figure and table. There is considerable variation in costs by year, ranging from \$5 to \$10 billion in 2007 to \$40 to \$75 billion in 2008. Large storms dominate these cost estimates. Outage costs due to Hurricane Ike in 2008 are estimated to be \$24 to \$45 billion while outage costs due to Superstorm Sandy in 2012 are estimated to be \$14 to \$26 billion.

Estimated Costs of Weather-Related Power Outages

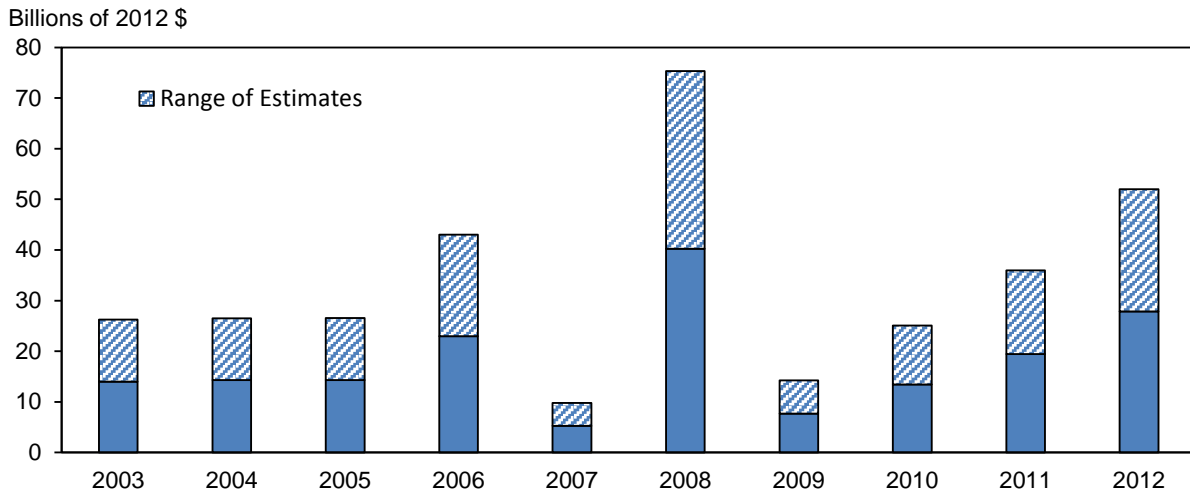

Source: CEA estimates using data from Census Bureau, Department of Energy , Energy I nformation Administration, Sullivan et al 2009.

Year	Estimated Cost of Weather Related Outages (Billions 2012 \$)
2012	\$27 – \$52
2011	\$19 – \$36
2010	\$13 – \$25
2009	\$8 – \$14
2008	\$40 – \$75
2007	\$5 – \$10
2006	\$23 – \$43
2005	\$14 – \$27
2004	\$14 – \$27
2003	\$14 – \$26

These estimates account for numerous costs associated with power outages including: lost output and wages, spoiled inventory, inconvenience and the cost of restarting industrial operations. The value of lost output can be calculated separately using the DOE MRDS and additional aggregate wage and output data. When calculated, the calculations show that between 20 and 25 percent of the annual cost of weather-related power outages are due to lost output.

Discussion

The methodology here is subject to a number of caveats. The (scaled) distribution of outages was estimated based on data from large storms and then applied to smaller storms. Although the analysis here suggests that the shape of the distribution does not depend on storm size, the shape could be different for small and large storms. Additionally, to the extent that businesses are prioritized for power restoration, the estimate in this report may overstate the actual cost of outages. On the other hand, because these estimates only account for storms with widespread outages, and because the majority of costs may come from the more-frequent momentary outages lasting less than 5 minutes (LaCommare and Eto 2005), the small storms neglected here could substantially add to the cost estimates.

Like the estimates discussed in the literature, the estimates in this report are based on private costs borne by customers who lose power. In addition to private costs, outages also produce externalities – both pecuniary and nonpecuniary. For example, outages that limit air transport produce negative network externalities throughout the country. Generally speaking, the costs of major outages are borne not only by those without power, but also by the millions of people inconvenienced in other ways.

The estimate in this report also differs from the effect of weather-related outages on GDP. Some of the lost GDP arising from storms is made up later by overtime hours, additional hiring, and additional consumption. For example, when the electrical grid goes down, the money spent on line crews to repair and replace grid components enters into GDP. Similarly, GDP is increased when a homeowner replaces spoiled food. These additional expenditures counteract the negative effect of the storm on GDP, but they do not increase welfare. Essentially, GDP is higher after a homeowner restocks the refrigerator – but the homeowner is worse off for having to do so.

Additional Benefits of Resilience

A more resilient electric grid brings a host of benefits beyond reduced vulnerability to severe weather. Investments in smart grid technology designed to increase resilience can improve the overall effectiveness of grid operations leading to greater efficiencies in energy use with accompanying reductions in carbon emissions, as well as providing greater assurances to businesses upon which our economy depends (U.S. DOE 2010b; 2011b). These technologies can also enhance national security by bolstering the nation's defense against cyber-attacks given that 99 percent of all U.S. Department of Defense installations located within the United States rely on the commercial electric grid for power (Samaras and Willis 2013).

Increased grid resilience may also reduce expenditures not directly captured in this paper's cost estimates: expenditures by firms and individuals on back-up generators, second utility feeds, power conditioning equipment and other items purchased to mitigate the effects of power outages.

Many of these additional benefits of grid resilience constitute positive externalities – societal benefits beyond the direct costs avoided by electric customers. For example, power outages can hinder public safety since police, firefighters and emergency medical personnel struggle to provide assistance during outages (Sullivan et al. 2009). Manufacturing businesses far removed from an outage may face economic costs if their supply chains are disturbed. Online businesses engaged in long-distance transactions may also be negatively affected by reduced internet traffic. These externalities are arguably large in dollar terms, but quantifying them goes beyond the scope of this report.

VI. Conclusion

The U.S. electric grid is highly vulnerable to severe weather. This report estimates the average annual cost of power outages caused by severe weather to be between \$18 billion and \$33 billion per year. In a year with record-breaking storms, the cost can be much higher. For example, weather-related outages cost the economy between \$40 billion and \$75 billion in 2008, the year of Hurricane Ike. These costs are expected to rise as climate change increases the frequency and intensity of hurricanes, tornadoes, blizzards and other extreme weather events.

Preparing for the challenges posed by climate change requires investment in 21st century technology that will increase the resilience and reliability of the grid. The Recovery Act allocated \$4.5 billion for investments in smart grid technologies.

A multi-dimensional strategy will prepare the United States for climate change and the increasing incidence of severe weather. Developing a smarter, more resilient electric grid is one step that can be taken now to ensure the welfare of the millions of current and future Americans who depend on the grid for reliable power.

Works Cited

- ABB Inc. "Energy Efficiency in the Power Grid." Norwalk, Connecticut. 2007.
- American Public Power Association. "U.S. Electric Utility Industry Statistics." *2012-2013 Annual Directory & Statistical Report*. Date?
- American Society of Civil Engineers. "Overview of Electricity Infrastructure." *Failure to Act: The Economic Impact of Current Investment Trends in Electricity Infrastructure*. April 26, 2012.
- Arrow, Kenneth et al. "Report of the NOAA Panel on Contingent Valuation." January 11, 1993.
- Avila, Lixion A. and Cangialosi, John. "Tropical Cyclone Report: Hurricane Irene." National Hurricane Center. December 14, 2011. Website.
- Blake, Eric S. et al. "Tropical Cyclone Report: Hurricane Sandy." National Hurricane Center. February 12, 2013. Website.
- Campbell, Richard J. "Weather-Related Power Outages and Electric System Resiliency." Congressional Research Service. August 28, 2012. Website.
- Carson, Richard T. "Contingent Valuation Surveys and Tests of Insensitivity to Scope." Australian Agricultural and Resource Economics Society, Conference (39th). February 14-16, 1995.
- Carson, Richard T. et al. "Was the NOAA Panel Correct about Contingent Valuation?" *Duke Economics Working Paper 96-21*. 1996.
- Edison Electric Institute. "Underground vs. Overhead Distribution Wires: Issues to Consider." Washington, D.C. Accessed July 22, 2013.
- Executive Office of the President. National Science and Technology Council. "A Policy Framework for the 21st Century Grid: A Progress Report." February 2013. Website.
- Federal Energy Regulatory Commission and the North American Electric Reliability Corporation. "Arizona-Southern California Outages on September 8, 2011: Causes and Recommendations." April 2012.
- Florida Power & Light Company. "FPL Announces Plan to Accelerate Strengthening of Florida's Electric Grid during Annual Storm Drill." Press Release. May 2, 2013.
- Foreit, James R. and Karen G. Fleischman Foreit. "The Reliability and Validity of Willingness to Pay Surveys for Reproductive Health Pricing Decisions in Developing Countries." *Health Policy* 63, 37-47. March 2002.

- Galvan, Floyd, Sujit Mandal and Mark Thomas. "The Role of Phasor Data in Emergency Operations." T&D World Magazine. December 1, 2008.
- Hines, Paul, Jay Apt, and Sarosh Talukdar. "Trends in the History of Large Blackouts in the United States." University of Vermont. 2008.
- Johnston, Robert J. and Deepack P. Joglekar. "Validating Hypothetical Surveys Using Binding Public Referenda: Implications for Stated Preference Valuation." American Agricultural Economics Association, Annual Meeting. July 24-27, 2005.
- Kossin, J. P., et al.. "A Globally Consistent Reanalysis of Hurricane Variability and Trends." *Geophysical Research Letters*. Vol. 34. 2007.
- LaCommare, Kristina Hamachi, and Joseph H. Eto. "Cost of Power Interruptions to Electricity Consumers in the United States." *Energy*, Vol. 31. Elsevier: April 7, 2005.
- Lawton, Leora et al. "Characteristics and Trends in a National Study of Consumer Outage Costs." Center for Research in Regulated Industries, 16th Annual Western Conference. June 25-27, 2003.
- Mendelsohn, Robert et al. "The Impact of Climate Change on Global References | 289 Tropical Cyclone Damage." *Nature Climate Change* Vol. 2. Pages 205-209. 2012.
- Mills, Evan. "Electric Grid Disruptions and Extreme Weather." Lawrence Berkeley National Laboratory. August 30, 2012. Website.
- Narita, Daiju, Richard S.J. Tol, and David Anthoff. "Damage Cost of Climate Change through Intensification of Tropical Cyclone Activities: An Application of FUND." *Climate Research*. Vol.39. Pages 87-97. 2009.
- National Climatic Data Center. National Oceanic and Atmospheric Administration. "NCDC Releases 2012 Billion-Dollar Weather and Climate Disasters Information." June 13, 2013. Website.
- Nordhaus, William. "Economic Aspects of Global Warming in a Post Copenhagen Environment." Yale University. 2010.
- North American Electric Reliability Corporation. "2012 Long-Term Reliability Assessment." November 2012.
- Pacific Northwest National Laboratory. Electricity Infrastructure Operations Center. *Massive Contingency Analysis and Visualization Tool*. Accessed June 21, 2013
- Paladino, Joe. "Results and Findings from the ARRA Smart Grid Projects." U.S. Department of Energy, Office of Electricity Delivery and Energy Reliability. Remarks at the 2013 MARC Annual Conference. June 12, 2013.

- Pfeifenberger, Johannes. "Transmission Investment Trends and Planning Challenges." The Brattle Group. August 8, 2012.
- Primen. "The Cost of Power Disturbances to Industrial and Digital Economy Companies." TR-1006274 (Available through EPRI). June 29, 2001.
- Samaras, Constantine and Henry H. Willis. "Capabilities-Based Planning for Energy Security at Department of Defense Installations." The RAND Corporation. 2013.
- Sullivan et al. "Estimated Value of Service Reliability for Electric Utility Customers in the United States." Ernest Orlando Lawrence Berkeley National Laboratory. June 2009.
- Swaminathan, S., and R. K. Sen. "Review of Power Quality Applications of Energy Storage Systems." Sandia National Laboratories. July 1998.
- The National Academies Press. "Disaster Resilience: A National Imperative." Committee on Increasing National Resilience to Hazards and Disasters, Committee on Science, Engineering, and Public Policy. 2012.
- U.S. Department of Commerce. National Oceanic and Atmospheric Administration (NOAA). "Irene by the Numbers." August 31, 2011. Website.
- U.S. Department of Commerce. National Oceanic and Atmospheric Administration (NOAA): National Climate Data Center. "Billion-Dollar Weather/Climate Disasters." June 13, 2013. Website.
- U.S. Department of Commerce. "NOAA Provides Easy Access to Historical Hurricane Tracks." August 13, 2012. Blog.
- U.S. Department of Energy. Office of Electricity Delivery and Energy Reliability. "Electric Disturbance Events (OE-417): Annual Summaries." Website.
- U.S. Department of Energy (2010a). Office of Electricity Delivery and Energy Reliability. "Hardening and Resiliency: U.S. Energy Industry Response to Recent Hurricane Seasons." August 2010.
- U.S. Department of Energy (2011a). Office of Electricity Delivery and Energy Reliability. "Hurricane Irene Situation Report #8." August 30, 2011. Website.
- U.S. Department of Energy (2012b). Office of Electricity Delivery and Energy Reliability. "Large Power Transformers and the U.S. Electric Grid." June 2012.
- U.S. Department of Energy (2010b). "The Smart Grid: An Estimation of the Energy and CO2 Benefits." Pacific Northwest National Laboratory. January 2010.
- U.S. Department of Energy (2011b). "Recovery Act Smart Grid Programs: Description of Benefits." May 2011.

U.S. Department of Energy (2012a). "Smart Grid Solutions Strengthen Electric Reliability and Customer Services in Florida." 2012.

U.S. Department of Energy. "U.S. Energy Sector Vulnerabilities to Climate Change and Extreme Weather." July 2013.

U.S. Energy Information Administration. "Electric Power Annual." Tables 2.1, 2.3, 8.3. January 30, 2013. Website.

U.S. Global Change Research Program. National Climate Assessment and Development Advisory Committee. "2009 Global Climate Change Impacts in the United States." 2009. Website.

U.S. Global Change Research Program. National Climate Assessment and Development Advisory Committee. "Our Changing Climate." Draft Version. January 11, 2013. Website.

Weiss, Daniel J. and Jackie Weidman. "Federal Community-Resilience Investments Swamped by Disaster Damages." Center for American Progress. June 19, 2013.